

How to add an old WBOX IP camera to a new NVR V4.2?

This article outlines the steps in adding the old WBOX cameras to the new WBOX NVR. This can also be used as a guide in adding other brands of IP cameras to the new WBOX NVR.

There are two methods that can use to add the camera to the NVR:

1. The camera is connected to the POE port of the NVR.
2. The camera is connected to a POE switch or a router.

Product Models:

NVR
WBXNV04P41S1T/ WBXNV04P41S
WBXNV08P82S2T/WBXNV08P82S
WBXNV16P164S4T/WBXNV16P164S

Firmware Version: V4.2.XXXX.0000.166.X.XX.X.X

The camera is connected to the POE ports of the NVR

Procedures:

1. Connect the camera and laptop/PC to the POE ports at the back panel of the NVR (not the LAN/Internet port). See image below.

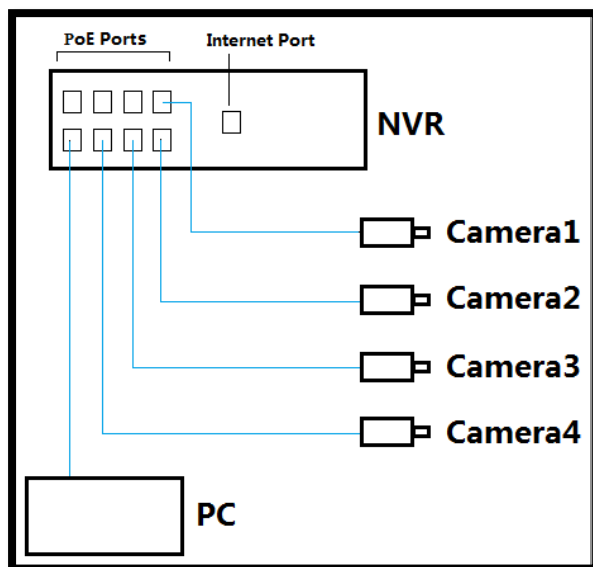

2. Check the POE IP address on the NVR.

- If you are adding several cameras that were previously added on another NVR, you need to change the POE IP address of the new NVR to the existing IP address range of the cameras.
- If the camera was never added to an NVR or just recently reset to factory setting, you may need to set the IP address of the camera to the same range as the POE IP address of the NVR.

The default POE IP address of the NVR is 169.254.10.121. You can find the POE IP address in [Setting > Network > POE](#)

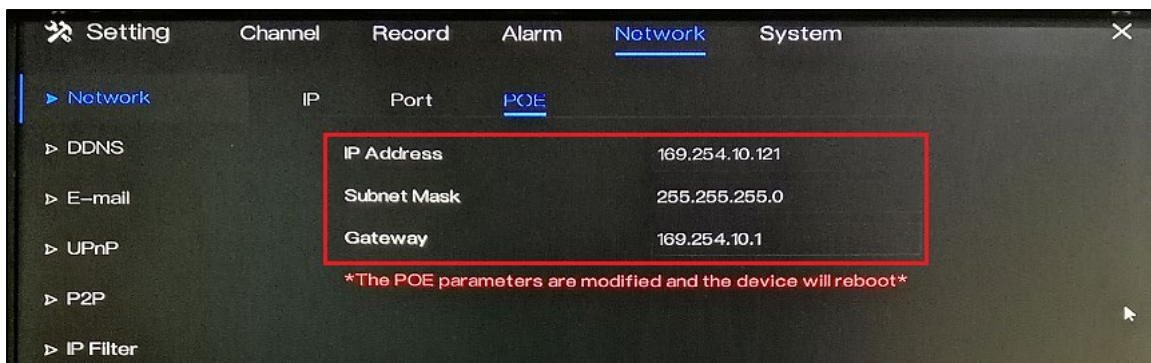

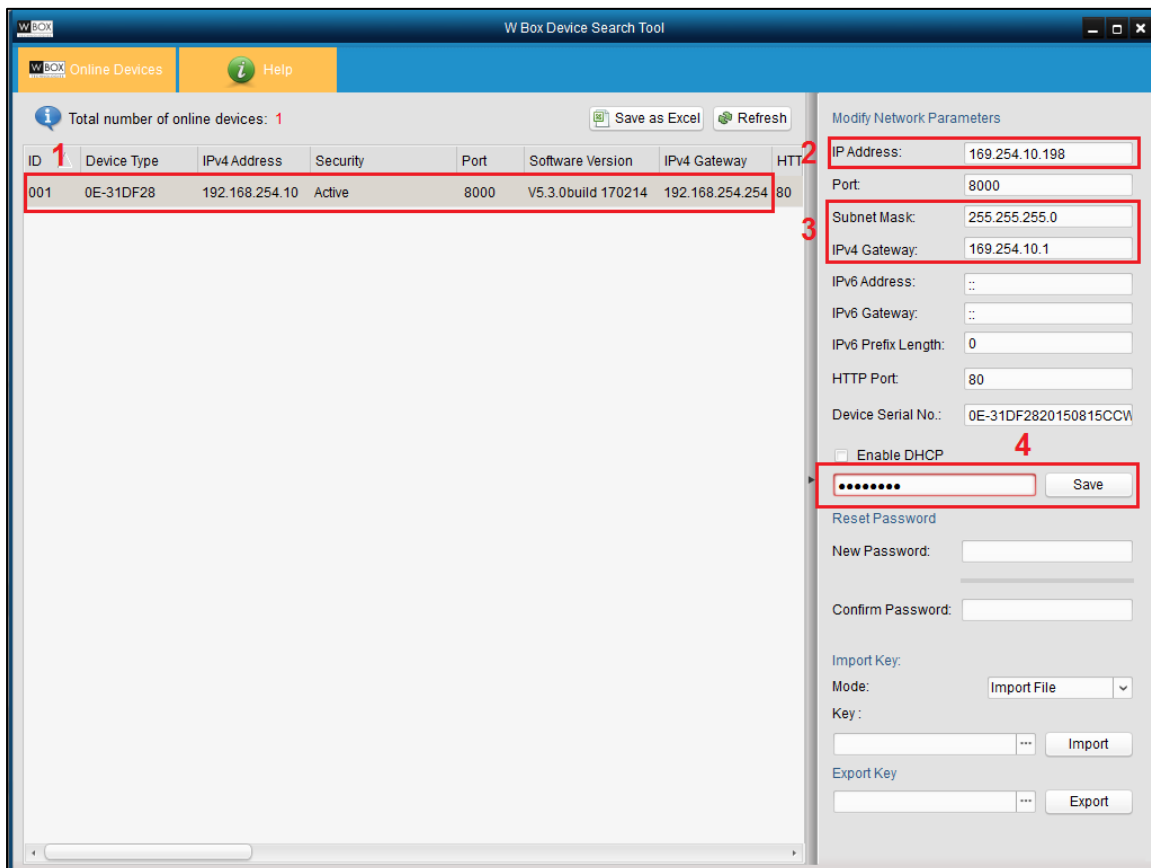

3. To change the IP address of the camera, you need to install the WBOX Device Tool on your PC. You can download the tool here: <http://bit.ly/2I1xRqa>.

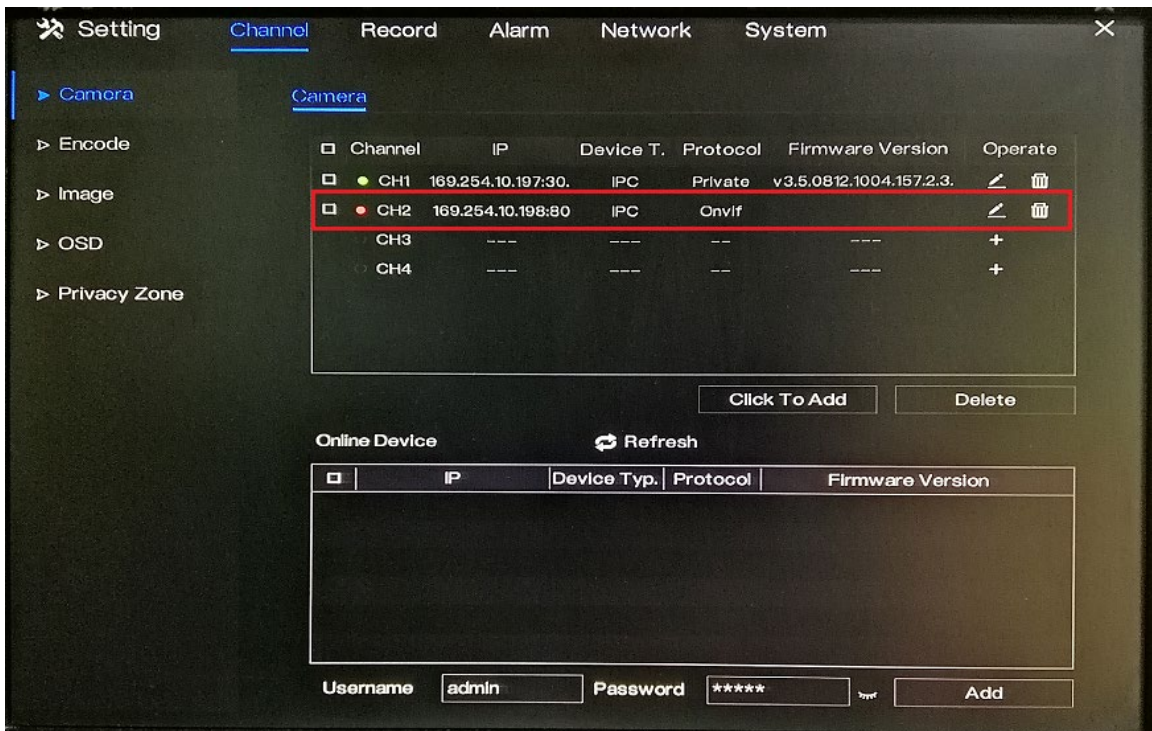

- [1] On the WBOX Device Search Tool, click the camera that you would like to modify the IP address.
- [2] On the right pane, input an **IP address** which is on the same range as the NVR's POE IP address.
- [3] Follow the **Subnet Mask** and **Default Gateway** on the NVR's POE setting.
- [4] Input the camera's password and hit **Save**.

- Once the camera's IP address and the NVR's POE IP address are on the same range, the NVR will automatically detect the camera. However, the status will be **OFFLINE** .



- Click the  icon. You will be prompted with screen below.



- Input the password of the camera in the **Password** field and hit **OK**.
- Once the camera is successfully added to the NVR, you will see an  icon beside the camera's channel number.

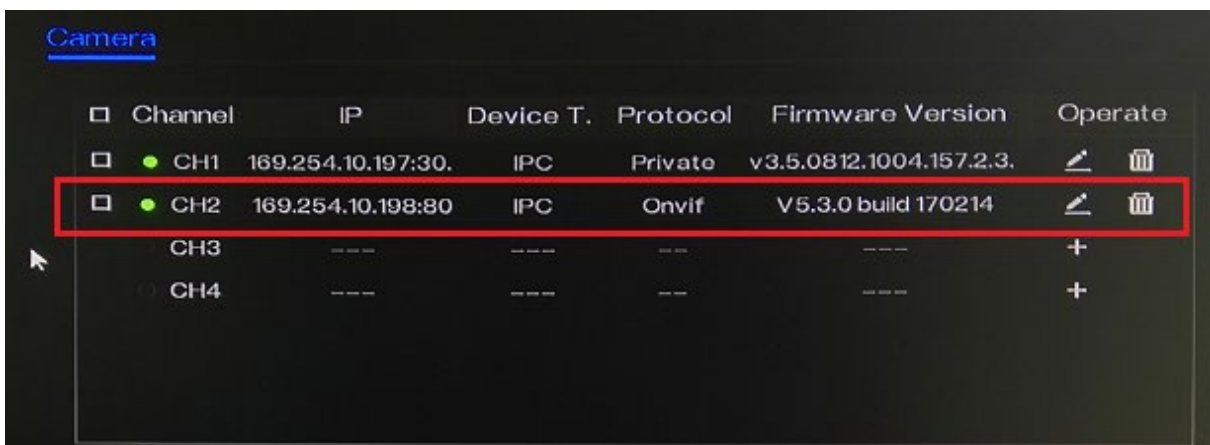

The cameras are connected to a POE Switch or Router

Procedures:

1. Make sure that the camera and the laptop are connected to the same network. See sample image below.

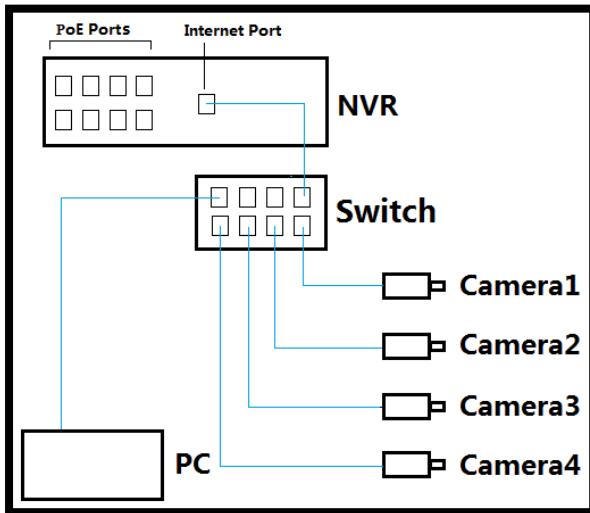

2. Check the IP address of the NVR. Go to **Setting > Network > Network > IP** on the NVR's monitor.

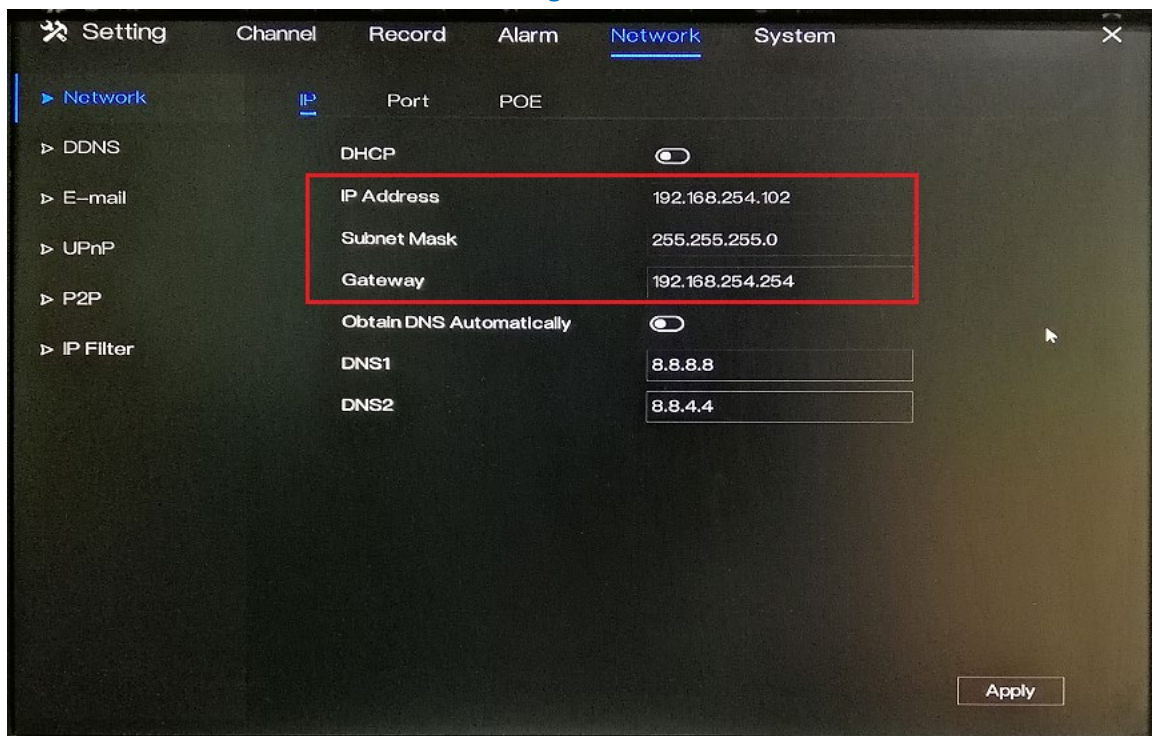

- Change the IP address of the camera using the WBOX Device Tool on your PC. You can download the tool here: <http://bit.ly/2l1xRqa>.

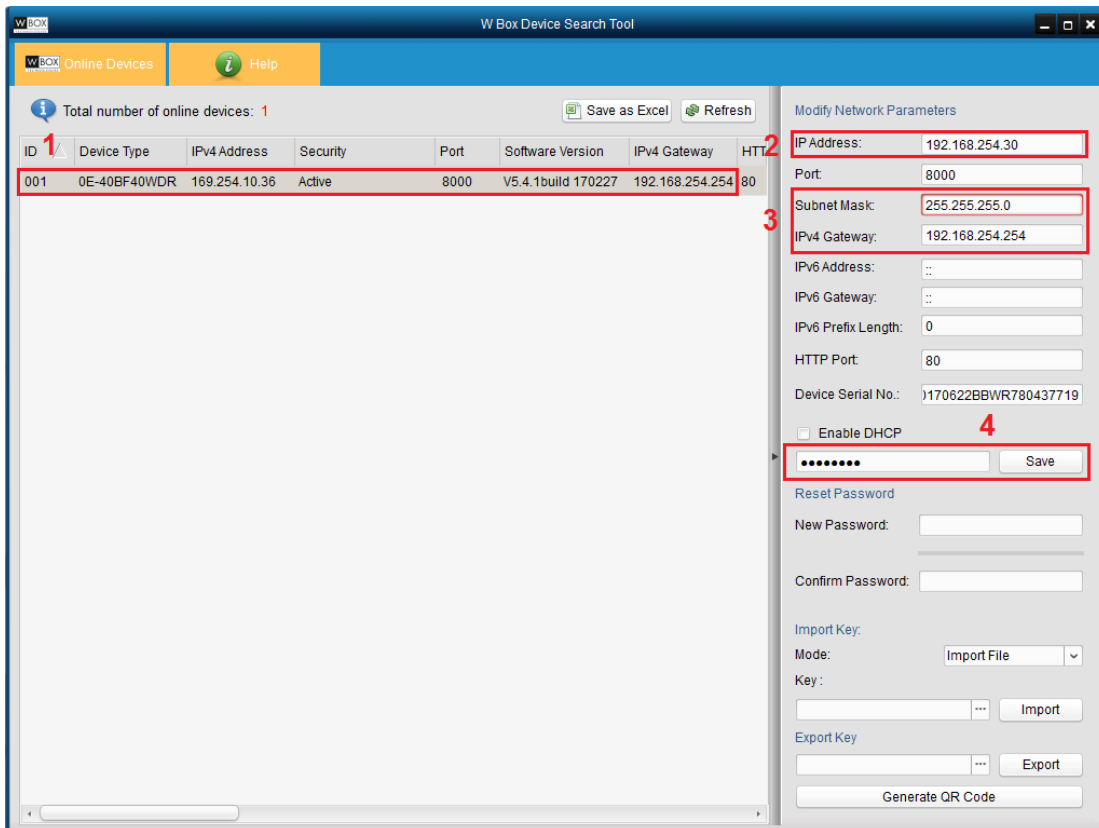

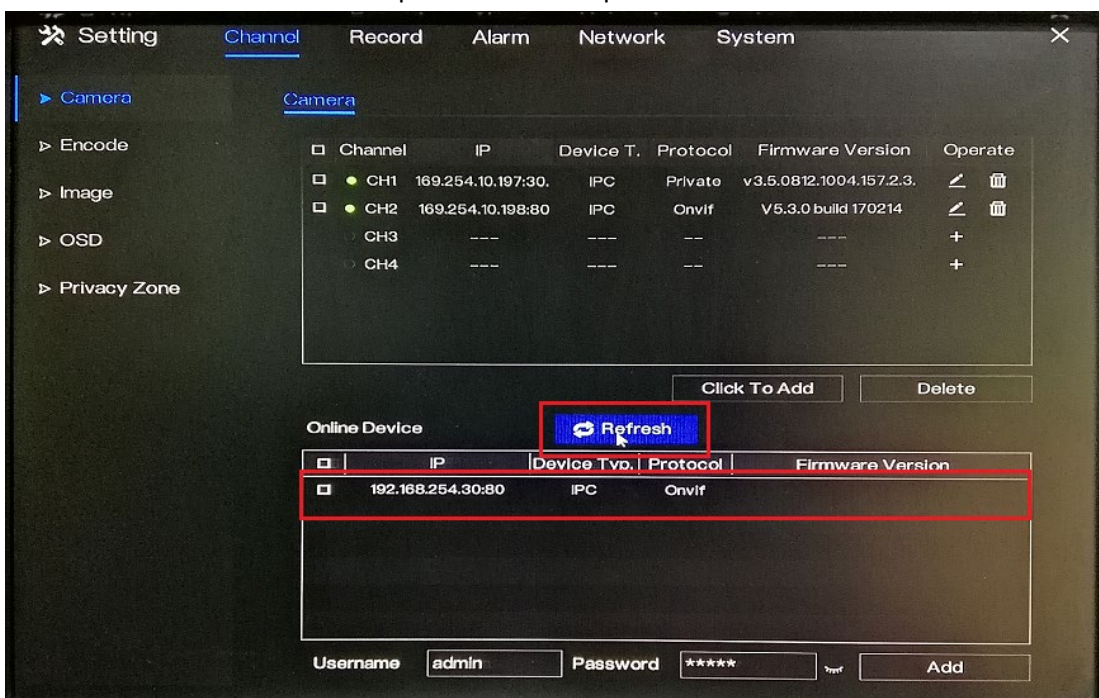

- On the WBOX Device Search Tool, click the camera that you would like to modify the IP address.
- On the right pane, input an **IP address** which is on the same range as the NVR's IP address and the router's default gateway.
- Follow the **Subnet Mask** and **Default Gateway** on the NVR's and the router's network setting.
- Input the camera's password and hit **Save**.

- On the NVR's monitor go to **Setting > Channel > Camera**. Click **Refresh**. The camera which is on the same network as the NVR and the computer will show up under **Online Device**.

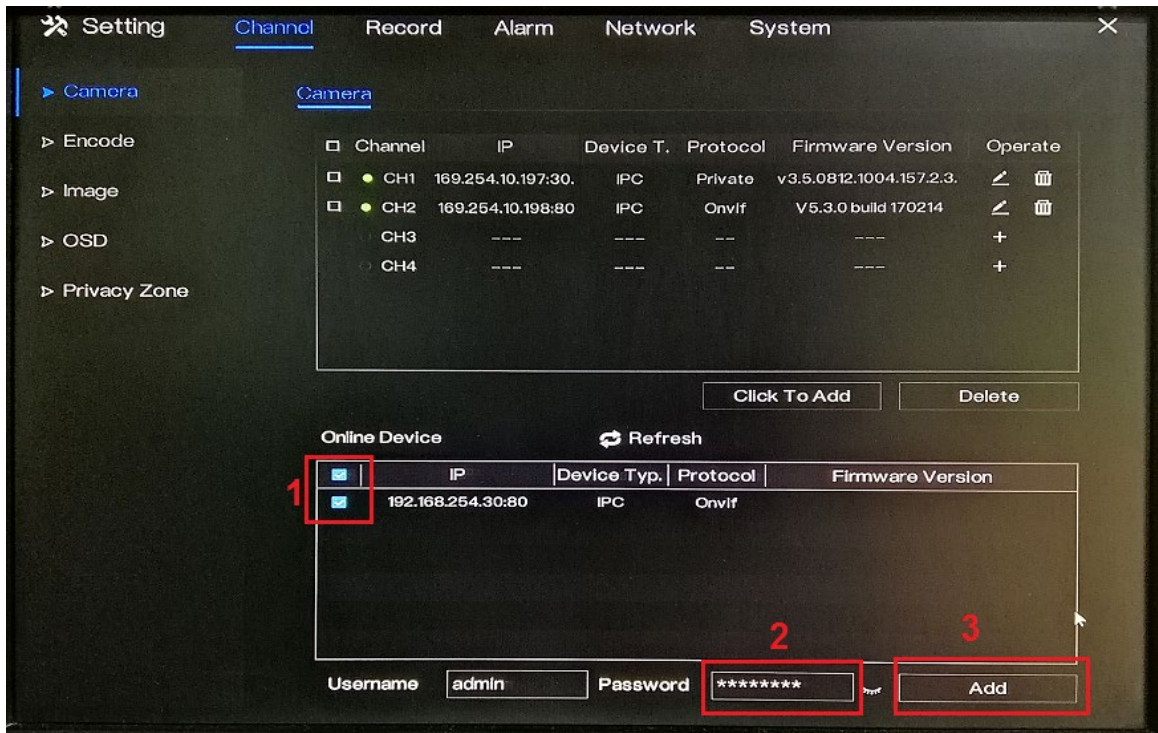

5. To add the camera, follow the steps below:
 - [1] Tick the checkbox beside the camera's IP address.
 - [2] Input the camera's password in the **Password** field.
 - [3] Click **Add**.



6. Once the camera is successfully added to the NVR, you will see an  icon beside the camera's channel number.

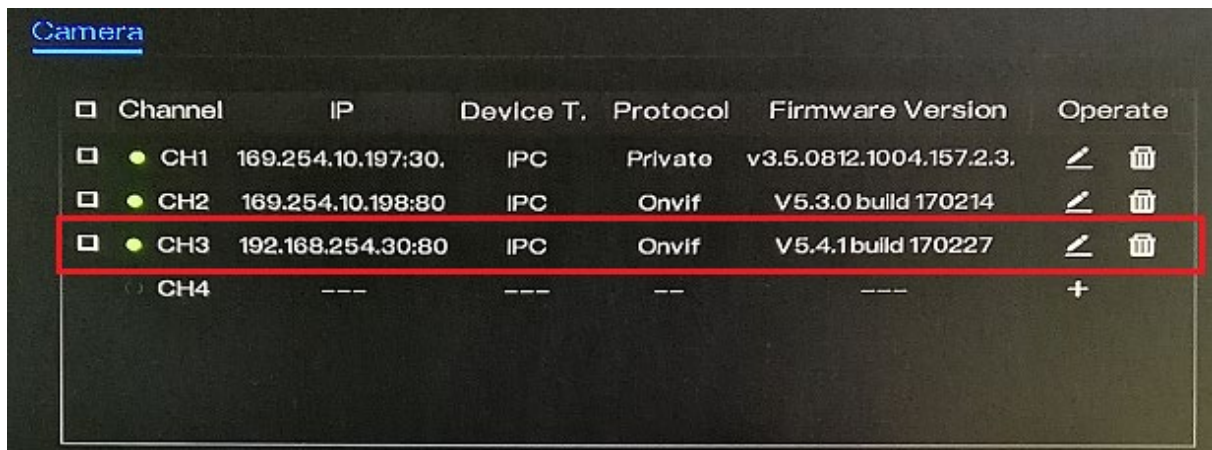

Additional Information: For OLD WBOX and HIKVISION IP Cameras

There is feature on the camera that will protect itself from wrong password attempts. If a wrong password was used to add the camera to the NVR for several times, the camera will not be added and will be locked for any other login attempt. To resolve this, follow the steps below:

1. Log in to the camera's web UI.
2. Go to **Configuration > System > Security > Security Service**.
3. Uncheck **Enable Illegal Login Lock** option.
4. Hit **Save**.

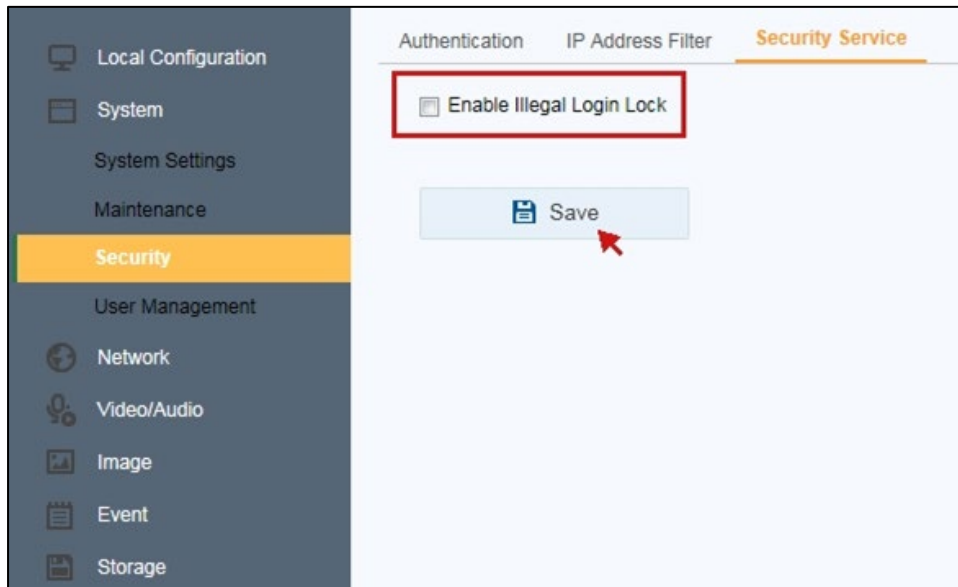
**For Hikvision cameras with firmware version V5.5.0, the ONVIF protocol is disabled.**

You need to log in to the camera's web UI to manually enable the ONVIF protocol and create an ONVIF account. Please see this link for the instructions. <https://www.hikvision.com/ueditor/net/upload/2017-11-13/c81ae947-b819-4859-b298-fb1ce1f463ac.pdf>.